

1. Barracuda Security Suite - Overview .....	2
1.1 What's New in the Barracuda Security Suite .....	2
1.1.1 Release Notes Version 1.1 .....	2
1.2 Deployment .....	3
1.3 Getting Started .....	5
1.3.1 Install the Barracuda Security Suite .....	5
1.3.2 Manage the Barracuda Security Suite Virtual Appliances .....	7
1.3.3 Initial Configuration of the Barracuda Firewall Vx .....	8
1.4 Maintenance .....	8
1.4.1 How to Shut Down and Restart the System .....	9
1.4.2 How to Update and Revert Firmware .....	9
1.4.3 Configuring Java Exception to Open Virtual Appliance Console - Microsoft Windows .....	10
1.4.4 Configuring Java Exception to Open Virtual Appliance Console - Apple Mac OS X .....	12
1.5 Barracuda Security Suite Hardware Features .....	14
1.6 Limited Warranty and License .....	15

# Barracuda Security Suite - Overview

en

The Barracuda Security Suite includes three network security solutions in one integrated platform to protect against current and future threats. It is a hardware appliance with a built in virtualization environment that includes the following Barracuda virtual appliances:

- **Barracuda Firewall:** Provides next-generation app control at a granular level, enabling administrators to grant permissions and regulate app usage to prevent network intrusions.
- **Barracuda Web Filter:** Provides content filtering and malware, virus and spyware protection, blocking website exposure for increased productivity.
- **Barracuda Spam Firewall:** Provides inbound and outbound email filtering to prevent email-borne threats and data leaks.

By default, all network traffic is routed into the Barracuda Security Suite through the Barracuda Firewall Vx. Email traffic can then be directed to the Barracuda Spam Firewall Vx and Internet traffic can be directed to the Barracuda Web Filter Vx. Effectively, the Barracuda Security Suite combines the functionality of these three Barracuda virtual appliances in a single hardware platform.

## Where to Start

### Device Deployment

- Go to the [Barracuda Security Suite Getting Started](#) section, or
- Download the [Barracuda Security Suite Quick Start Guide](#)

## What's New in the Barracuda Security Suite

en

### What's New in Version 1.1

**Single sign on:** Now when you sign on to the Barracuda Security Suite, you are automatically signed on to the Barracuda Web Filter Vx and the Barracuda Spam Firewall Vx as well.

For detailed information on the fixes and enhancements that are included in Barracuda Security Suite version 1.1, see:

- [Release Notes Version 1.1](#)

### Release Notes Version 1.1

en



Before installing any firmware version, back up your configuration and read all release notes that apply to versions more recent than the one currently running on your system.

**Do not manually reboot your system at any time during an update** unless otherwise instructed by [Barracuda Technical Support](#). Depending on your current firmware version and other system factors, updating can take up to 10 minutes. If the process takes longer, contact Barracuda Technical Support for further assistance.

## New Features

- Single Sign-On (SSO) is now available between the Barracuda Security Suite and the Barracuda Web Filter Vx and the Barracuda Spam Firewall Vx.
- The **Shutdown** and **Restart** options are now available on the **BASIC > Administration** page.
- There is now a button on the **BASIC > Dashboard** page enabling you to force shut down any of the Barracuda Security Suite virtual machines.
- The Barracuda Web Filter Vx now automatically blocks certain categories of predefined websites.
- You can now modify the Management port IP address with the assistance of [Barracuda Technical Support](#).

## Known Issue

- If you have opened a support tunnel on the Barracuda Firewall Vx and you then restart the Barracuda Security Suite, when the Barracuda Security Suite comes back up, the support tunnel on the Barracuda Firewall Vx does not work. You will need to reestablish the support

tunnel. [BNSS-93]

## Fixes

- Output from the environmental sensors are now displayed on the **BASIC > Dashboard** page. [BNSS-60]
- The Barracuda Web Filter Vx can now manage additional virtual IP addresses. The **ADVANCED > Advanced Networking** page is now available. And a virtual interface can now be assigned to a bridge device. [BNSS-83]
- The Barracuda Web Filter Vx and the Barracuda Spam Firewall Vx are now automatically rebooted after the Barracuda Security Suite is restarted from suspend mode. [BNSS-181]

## Deployment

en

### Barracuda Security Suite Ports and Internal Network

This diagram illustrates the virtual network in the Barracuda Security Suite interconnecting the web interface with the Barracuda virtual appliances. Ensure that the virtual appliance internal IP addresses do not conflict with other devices in your internal network. The diagram also illustrates how the physical ports are connected to the virtual appliances. Most of the ports are connected to just the Barracuda Firewall Vx. LAN4 is connected to the Barracuda Web Filter Vx. The MGMT port is connected to the Barracuda Security Suite web interface.

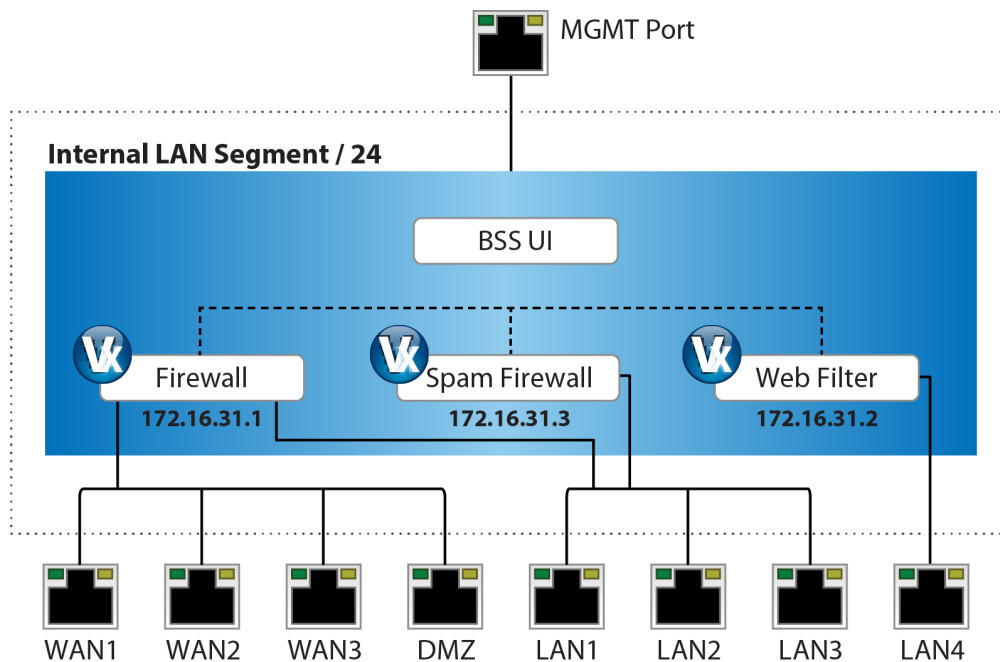

**i** Do not change the default IP addresses. You could lose access to one or more of the virtual appliances.

The following table lists all of the physical ports available on the Barracuda Security Suite and their function:

Port	Function
MGMT	Management
WAN1	Connect to Internet
WAN2	Disabled by default
WAN3	Disabled by default
DMZ	Disabled by default
LAN1	Connect to Internal Network
LAN2	Disabled by default

LAN3	Disabled by default
LAN4	Connect to Web Filter Clients

The disabled ports can be enabled using the Barracuda Firewall Vx user interface.

### Barracuda Security Suite Deployment

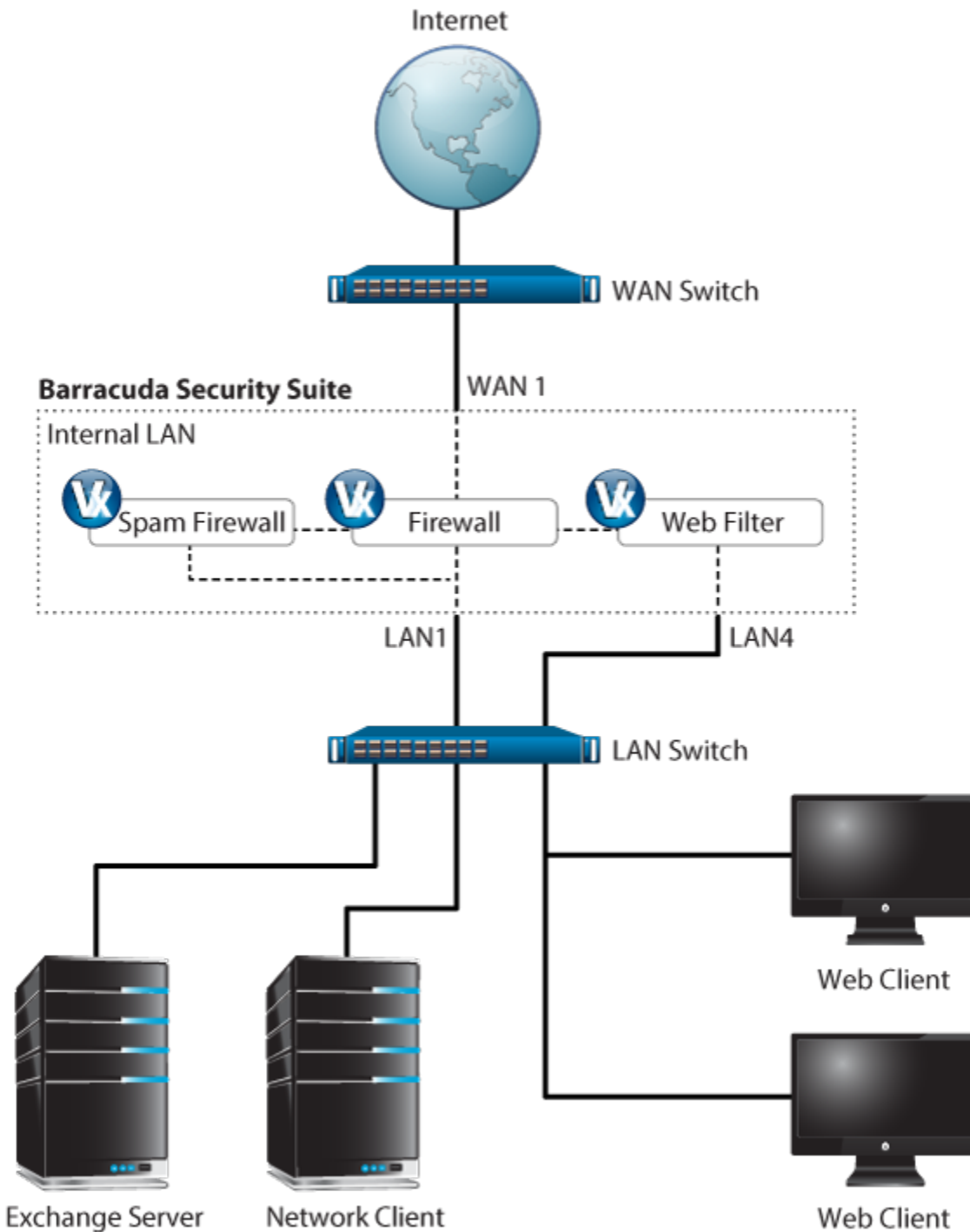

1. Connect the **WAN1** port to a DHCP enabled switch or router connected to the Internet. The Barracuda Security Suite should

automatically obtain the uplink WAN IP address.

2. You can also statically assign WAN IP address from within the Barracuda Firewall Vx and bind the static WAN IP address to port **WAN2**.
3. **LAN1** handles traffic coming directly from the Barracuda Firewall Vx and carries any email traffic from the Barracuda Spam Firewall Vx destined for your email server. It also carries any general network traffic. **LAN1** traffic bypasses the Barracuda Web Filter Vx.
4. **LAN4** handles traffic coming directly from the Barracuda Security Suite Web Filter. The filtered traffic is forwarded to web clients (http or https) on the internal network.

## Getting Started

en

The following instructions are an expanded version of the [Barracuda Security Suite Quick Start Guide](#) that is shipped with every Barracuda Security Suite:

- [Install the Barracuda Security Suite](#)
- [Manage the Barracuda Security Suite Virtual Appliances](#)
- [Initial Configuration of the Barracuda Firewall Vx](#)

## Install the Barracuda Security Suite

en

### Verify Equipment

Verify you have the necessary equipment:

- Barracuda Security Suite
- AC power cord
- Ethernet cables
- Mounting rails and screws
- Monitor and keyboard (recommended)

### Initial Hardware Setup and Port Connections

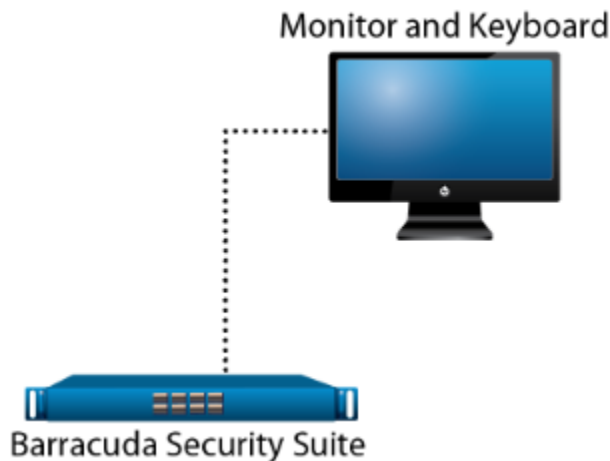

1. Install the Barracuda Security Suite into a standard networking equipment rack.
2. Connect a power cord, monitor, and keyboard to the ports on the back of the Barracuda Security Suite.
3. Connect the WAN1 port to a DHCP-enabled link with access to the Internet. Connect the MGMT port and the LAN1 port or LAN4 port to the same network switch. The default address for the MGMT port is 172.16.31.254.
4. Connect a client PC to the switch connected to LAN1 or LAN4 and MGMT. The Barracuda Security Suite is pre-configured with a default DHCP service range of 172.16.31.100 to 172.16.31.150 (giving you more than 100 IPv4 addresses to work with). DHCP should automatically assign the client PC an IP address within this range.



The default management IP address (172.16.31.254) should only be modified as a troubleshooting step when other means of establishing access to Barracuda Technical Support have been exhausted.

To change the management IP address, first move the Ethernet cable from the WAN1 port to the MGMT port located on the back of the box. Now, from the console (accessible using a directly connected monitor and keyboard), assign an IP address

which is routable upstream and open the support tunnel for assistance.

 The client PC should be able to access the Internet (through the Barracuda Firewall Vx) at this time. It should also be able to manage the Barracuda Security Suite virtual appliances.

### **Login to the Barracuda Security Suite**

1. In a web browser, enter the Barracuda Security Suite management IP address and default HTTP port (for example, <http://172.16.31.254/>).
2. If you receive a certificate warning, ignore the warning and proceed. Use the default administrator login credentials:
  - **Password:** admin
  - **Username:** admin

 Do not change the default IP addresses (172.16.31.x), this could cause a loss of connectivity and prevent normal operation. If you are using a different internal sub-network please see [Integrate the Barracuda Security Suite into an Existing Network](#).

### **Activate the Barracuda Security Suite**

If your Barracuda Security Suite is connected to the Internet, it can automatically update its activation status. Complete the following steps to initiate the online activation process:

1. Go to the **BASIC > Dashboard** page and view the **Subscription Status** section to verify that your Energize Update subscription status is *Current*. If the Barracuda Security Suite can access the activation servers, your Energize Update and Instant Replacement subscriptions are should be active. If not, a warning is displayed at the top of every page and you must activate your subscription before continuing.
2. If the status of the Energize Updates subscription is *Not Activated*, complete the following steps:
  - a. Click the activation link at the top of the page and complete your subscription activation.

 The activation process takes approximately 30 minutes. During this time, it is important to leave the Barracuda Security Suite connected to the Internet and to not attempt to modify the configuration.

- b. Go back to the **Subscription Status** section of the **BASIC > Dashboard** page and click **Refresh** to automatically update the activation status of the Energize Updates subscription.
3. The Barracuda Security Suite should now be up and running. Traffic should be passing from the Internet through LAN1 or LAN4 to your internal clients. You can now begin to customize the configuration of the Barracuda Security Suite virtual appliances.

### **Update the Barracuda Security Suite Firmware**

Complete the following steps to check for and install updates to the Barracuda Security Suite firmware:

1. Go to the **ADVANCED > Firmware Update** page and verify that the currently installed version is the latest general release that is available. If you have the latest firmware version already installed, the **Download Now** button for the latest general release version is disabled.
2. If there is a new **Latest General Release** available:
  - a. Click **Download Now** and allow the update to finish downloading.
  - b. After the update is completely downloaded, click **Apply Now**. Do not reboot or turn off the Barracuda Security Suite while the firmware is updating. After the process completes, the Barracuda Security Suite automatically reboots and you are redirected to the page to log back into the system.

### **Change the Administrator Password**

To ensure the integrity of the Barracuda Security Suite, it is important to change the administrator password. Go to the **BASIC > Administration** page, and change the administrator password in the **Password Change** section.

### **Integrate the Barracuda Security Suite into an Existing Network**

If the sub-network does not need to be filtered by the Barracuda Web Filter Vx, assign an address within the sub-network to either the LAN2 or LAN3 interface to act as the default gateway for those clients.

If the sub-network needs to be filtered by the Barracuda Web Filter Vx, you need to complete the following configuration (the following example uses the 192.168.1.x IPv4 address space):

- On the Barracuda Firewall Vx, configure an IPv4 address on the LAN1 or LAN4 on the **Network -> IP Configuration** page. This address will be the default gateway address for the clients and the virtual interface that is added in the Barracuda Web Filter Vx (for example 192.168.1.1/24).
  - If the cable is physically connected to the LAN4 interface, configure IP on the LAN1 interface.
  - If the cable is physically connected to the LAN1 interface, configure IP on the LAN4 interface. This is required by the Software Defined Networking (SDN) configuration on the host virtual operating system.
- Create a virtual interface on the Barracuda Web Filter Vx by navigating to the **Advanced -> Advanced Networking** page and adding a virtual interface in the same 192.168.1.2/24 sub-network using the 192.168.1.1 default gateway. This virtual interface must be assigned to device **Bridge**, not **LAN**.

VIRTUAL INTERFACES				Help
IP ADDRESS	NETMASK	GATEWAY ADDRESS	DEVICE	
192 . 168 . 1 . 2	255 . 255 . 255 . 0	192 . 168 . 1 . 1	Bridge	<input type="button" value="Add"/>

Add a virtual interface for routing a VLAN or subnet to the Barracuda Web Filter.

You can confirm that traffic is flowing as designed by generating traffic from a client using the 192.168.1.x network. You can verify that the Barracuda Web Filter Vx can see the traffic from the client in both the Barracuda Web Filter Vx web log and the Barracuda Firewall Vx firewall log. You can also confirm that the Barracuda Web Filter Vx policies are being applied properly.

### Complete the Initial Configuration

Complete the following steps to finish the initial configuration of the Barracuda Security Suite. These steps include specifying a host name, a network domain, and and SMTP server.

- On the Barracuda Security Suite, navigate to the **BASIC -> IP Configuration** page to customize the host name and network domain displayed in alerts, notifications, and messages sent by the device. If you configure the two example values shown below, alerts, notifications, and messages will display the name `security.yourcompany.com`.
  - Default Hostname:** Displayed in alerts, notifications, and messages sent by the Barracuda Security Suite. Example text string: `security`
  - Default Domain** - Displayed in alerts, notifications, and messages sent by the Barracuda Security Suite. Example text string: `yourcompany.org`
- Navigate to the **BASIC -> Administration** page and specify the SMTP server used for sending system alerts from the Barracuda Security Suite.
  - SMTP Host** - Mail server to use for sending notifications.
  - SMTP Port** - SMTP port of the notification mail server. If no port number is specified, the Barracuda Security Suite uses the default port of **20025**.

## Manage the Barracuda Security Suite Virtual Appliances

en

You can launch the UI for each of the virtual appliances by clicking on **Manage** in the Barracuda Security Suite user interface.

VIRTUAL MACHINES					
Name	Status	CPU	Memory		
Firewall	Running	26%	25%	<input type="button" value="Manage"/>	
Web Filter	Running	12%	5%	<input type="button" value="Manage"/>	
Spam Firewall	Running	5%	13%	<input type="button" value="Manage"/>	

Each of the virtual appliances has the same functionality as its respective physical appliance. See the Barracuda TechLibrary for detailed information on how to configure each of these virtual appliances:

- Barracuda Firewall: <https://techlib.barracuda.com/BFW>
- Barracuda Web Filter: <https://techlib.barracuda.com/BWF/Overview>
- Barracuda Spam Firewall: <https://techlib.barracuda.com/BSF/Overview>

The Barracuda Firewall Vx acts as the initial entry point for all traffic passing through the Barracuda Security Suite. As such, it is important to first

configure the policies on the Barracuda Firewall Vx, before proceeding to configure the Barracuda Web Filter Vx and the Barracuda Spam Firewall Vx.

**i** A DNS server is not configured on the Barracuda Firewall Vx by default. You can add the DNS server to the configuration from the Barracuda Firewall Vx user interface by navigating to the **Network > IP Configuration** page.

If you are routing Internet traffic through the Barracuda Web Filter Vx (port LAN4), note that the default configuration of the Web Filter is to allow all traffic to pass through to clients. You need to configure policies to begin to filter Internet traffic.

## Initial Configuration of the Barracuda Firewall Vx

en

**i** Do not change the IP address for the management port of the Barracuda Firewall Vx. Please contact Barracuda technical support for more information.

**i** Please be aware of the following with regards to the Barracuda Firewall Vx and the Barracuda Security Suite:

- A DNS server is not configured on the Barracuda Firewall Vx by default. You can add the DNS server to the configuration from the Barracuda Firewall Vx user interface by navigating to the **Network > IP Configuration** page.

You need to add your internal subnetwork as a destination in *both the LAN-2-INTERNET and BYF-BSF-2-INTERNET* firewall rules:

1. In the Barracuda Firewall Vx user interface, navigate to **Firewall > Firewall Rules**.
2. Click the edit icon next to the LAN-2-INTERNET firewall rule (repeat this procedure later for the BYF-BSF-2-INTERNET).
3. Using the Destination module, add your internal subnetwork.

For example, you could add one of the internal IP address ranges (depending on your network):

- 10.0.0.0/8
- 172.16.0.0/12
- 192.168.0.0/16

**EDIT ACCESS RULE** Help

General **ADVANCED**

Action: **Allow**  **Deny**

Name: LAN-2-INTERNET

Description: Allows internet access from Trusted LAN for typical applications.

Connection: Default (SNAT)

Adjust Bandwidth: Internet

Bi-directional:  Yes  No

Disable:  Yes  No

IPS:  Yes  No

Application Control:  Yes  No

URL Filter:  Yes  No

Virus Protection:  Yes  No

SSL Inspection:  Yes  No

*DNAT (port forwarding) - Redirect traffic to a specific IP address.*

*Redirect to Service - Redirect traffic to a service on the Barracuda Firewall.*

*Bi-directional - Source and destination networks are interchangeable.*

*The interface must have bandwidth management enabled on the NETWORK > IP Configuration page for this policy to be applied.*

*URL Filter, Virus Protection and SSL Inspection depend on Application Control enabled. URL Filter and Virus Protection require a valid Web Security subscription.*

SOURCE	Help
Any	<input type="button" value="+"/>
Ref: Any	<input type="button" value="-"/>

NETWORK SERVICES	Help
Any	<input type="button" value="+"/>
Any	<input type="button" value="-"/>

DESTINATION	Help
10.0.0.0/8	<input type="button" value="+"/>
Ref: Any	<input type="button" value="-"/>

Network Objects  IP Address  Geo Loc.

## Maintenance

en

In this Section



- [How to Shut Down and Restart the System](#)
- [How to Update and Revert Firmware](#)
- [Configuring Java Exception to Open Virtual Appliance Console - Microsoft Windows](#)
- [Configuring Java Exception to Open Virtual Appliance Console - Apple Mac OS X](#)

## How to Shut Down and Restart the System

en

The **System Management** section on the **BASIC > Administration** page allows you to shutdown and restart the Barracuda Security Suite:

- **Shutdown** - Shuts down and powers OFF the Barracuda Security Suite.
- **Restart** - Restarts the Barracuda Security Suite.

You can also restart the Barracuda Security Suite by pressing **RESET** on the front panel.

 During a restart, the Barracuda Web Filter Vx and the Barracuda Spam Firewall Vx are also restarted. The Barracuda Firewall Vx is suspended and returns to its normal state once the Barracuda Security Suite is up and running again.

## How to Update and Revert Firmware

en

 Always update the firmware on the Barracuda Security Suite appliance itself before updating the firmware of the virtual appliances.

On the **ADVANCED > Firmware Update** page, you can update or revert the firmware version of the Barracuda Security Suite.

Because the Barracuda Security Suite reboots during the firmware update, it is recommended that you update the firmware in a planned maintenance window.

### In this article:

- en

[Before You Update the Firmware](#)

[Firmware Update for the Barracuda Security Suite](#)

[Firmware Update for the Barracuda Security Suite Virtual Appliances](#)

### ***Before You Update the Firmware***

Before you update the firmware version of the Barracuda Security Suite, it is strongly recommended that you:

- Read all release notes that apply to versions that are more recent than the one currently running on your system. You can view the release notes on the **ADVANCED > Firmware Update** page. If you are performing an offline firmware update, the release notes appear after you upload the firmware update package with the steps in the [Offline Firmware Update](#) section below.

### ***Firmware Update for the Barracuda Security Suite***

To update the firmware for the Barracuda Security Suite:

1. Go to the **ADVANCED > Firmware Update** page.
2. Compare the installed version in the **Current Firmware Version** section to the latest general release version available in the **Firmware Download** section. If you have the latest firmware version already installed, the **Download Now** button for the latest general release version is disabled.
3. If there is a new **Latest General Release** available, click **Download Now** and allow the update to finish downloading.
4. After the update is completely downloaded, click **Apply Now**.

Do not reboot or turn off the Barracuda Load Security Suite while the firmware is updating. The process can take several minutes to complete, depending on your configuration. After the firmware finishes updating, the Barracuda Security Suite automatically reboots and you are redirected to the login screen.

## Firmware Update for the Barracuda Security Suite Virtual Appliances

For documentation on how to update the firmware for a Barracuda Security Suite virtual appliance, refer to the online help for the virtual appliance or refer to the documentation for the virtual appliance on the [Barracuda TechLibrary](#).

## Configuring Java Exception to Open Virtual Appliance Console - Microsoft Windows

en

 This procedure is available on version 1.2 of the firmware.

Complete the following steps to configure a Java security exception to allow you to open a console window for the virtual appliances in the Barracuda Security Suite. The console window can give you access to some of the underlying functionality and settings of the virtual appliances.

1. Select **Windows -> All Programs**.
2. Select **Java -> Configure Java** to open the Java Control Panel.
3. Select the **Security** tab and click **Edit Site List**.

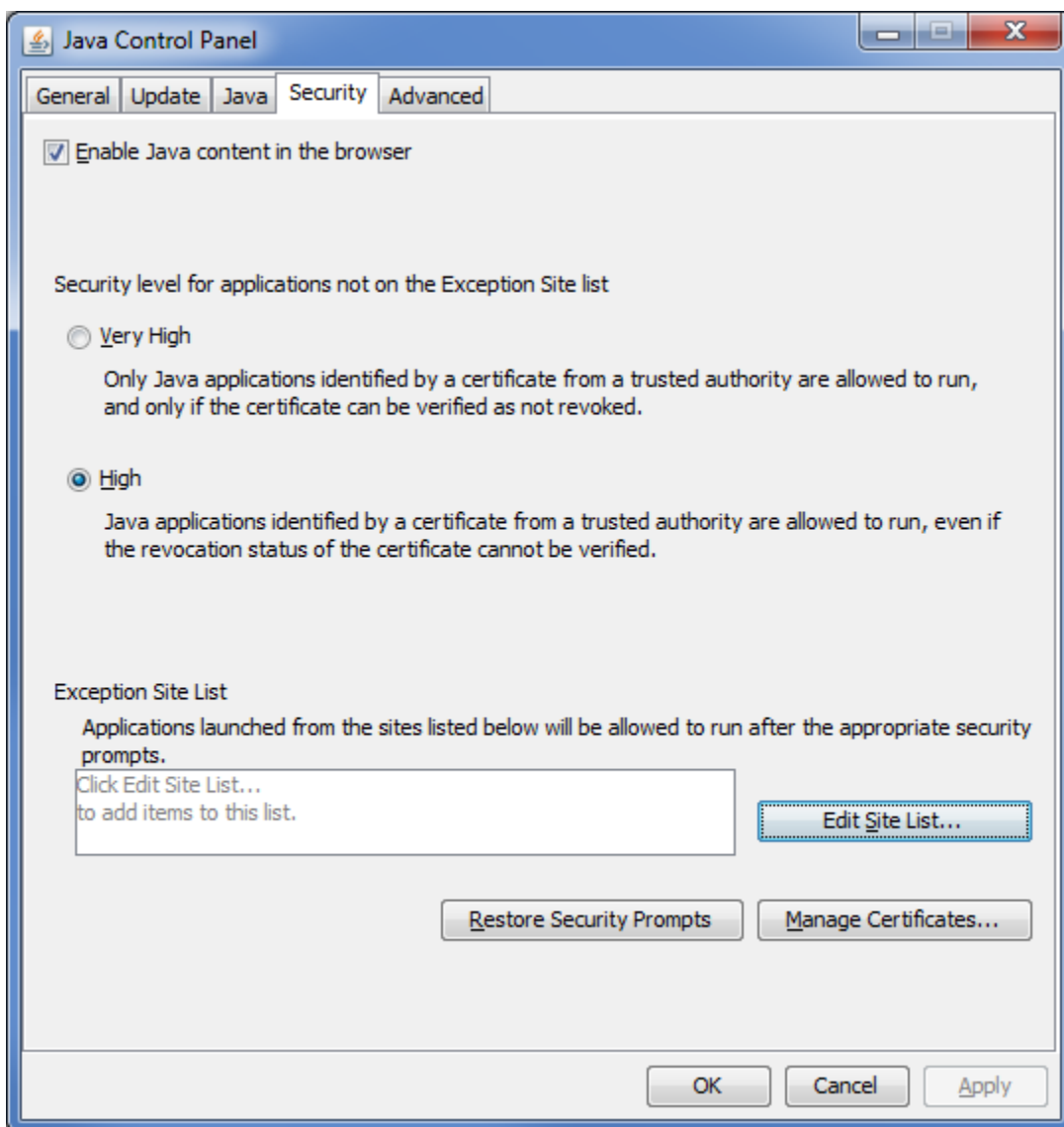

4. Click **Add** and enter the following URL: `http://172.16.31.254`

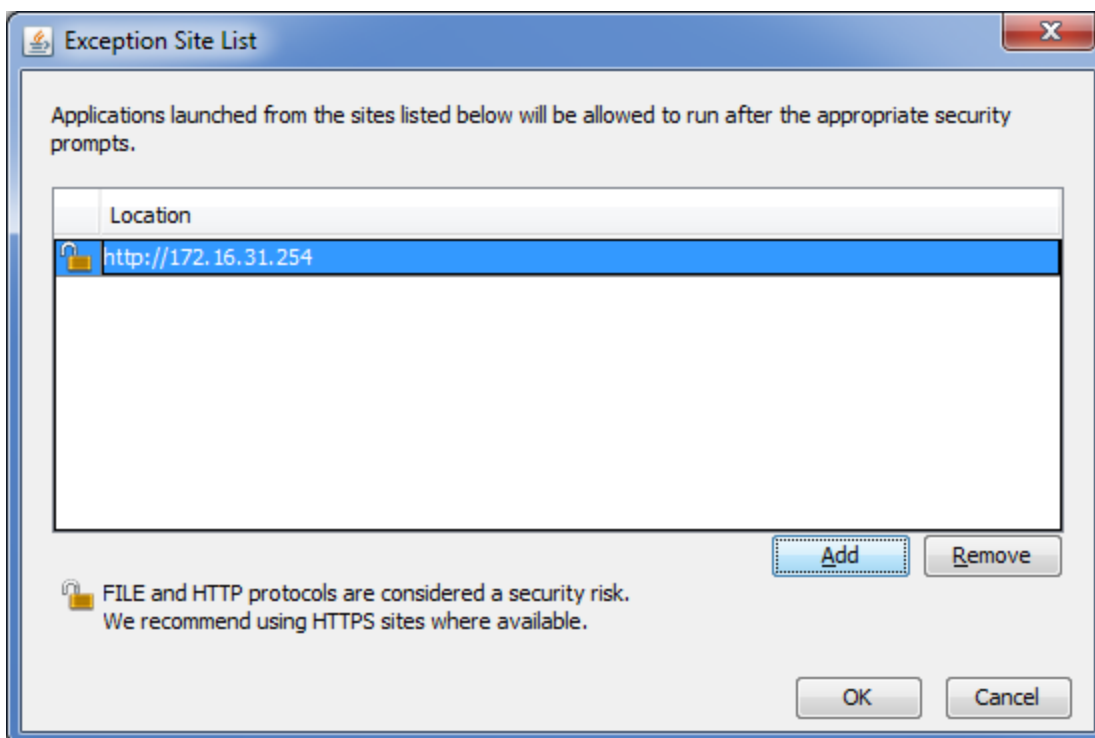

5. Click **OK** and then click **Continue** in the warning message window.

### ***Opening VNC in the Barracuda Security Suite User Interface***

From the Barracuda Security Suite UI, click the **VNC** button for the virtual appliance. A console window is opened.

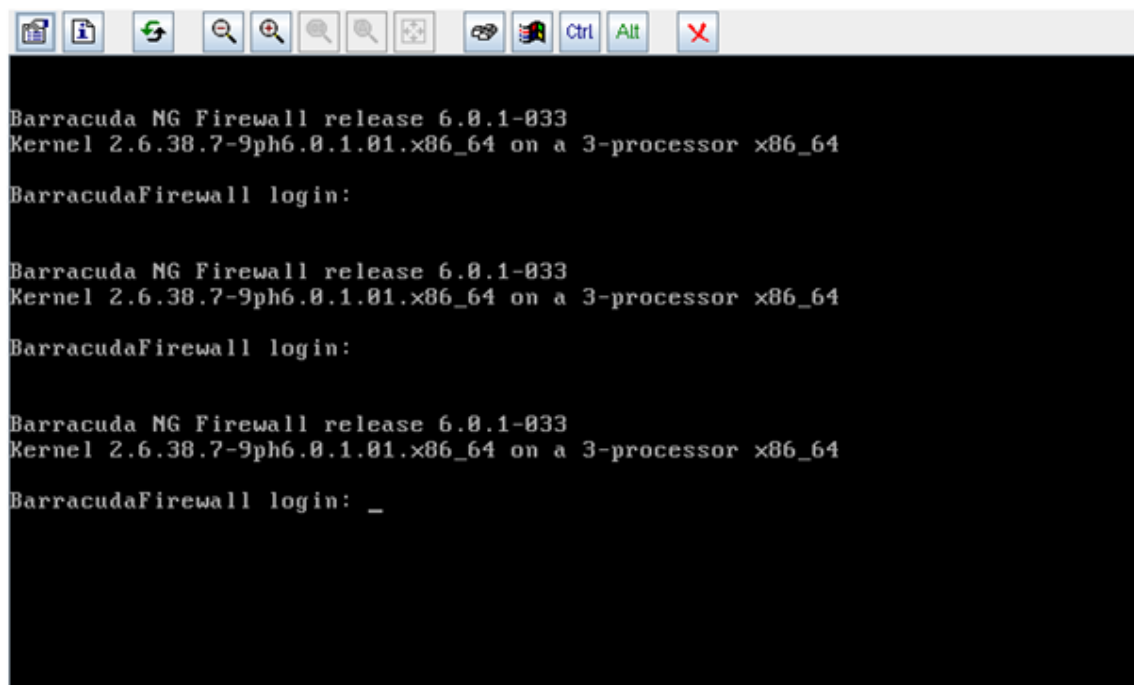

### ***Procedure for Google Chrome Browser.***

If you use the Google Chrome browser, you also need to complete to enable the NPAPI plugins:

1. Launch the Google Chrome browser.
2. In the address bar at the top of the screen, enter the following: `chrome://flags/#enable-npapi`

3. Under **Enable NPAPI**, click **Enable**.

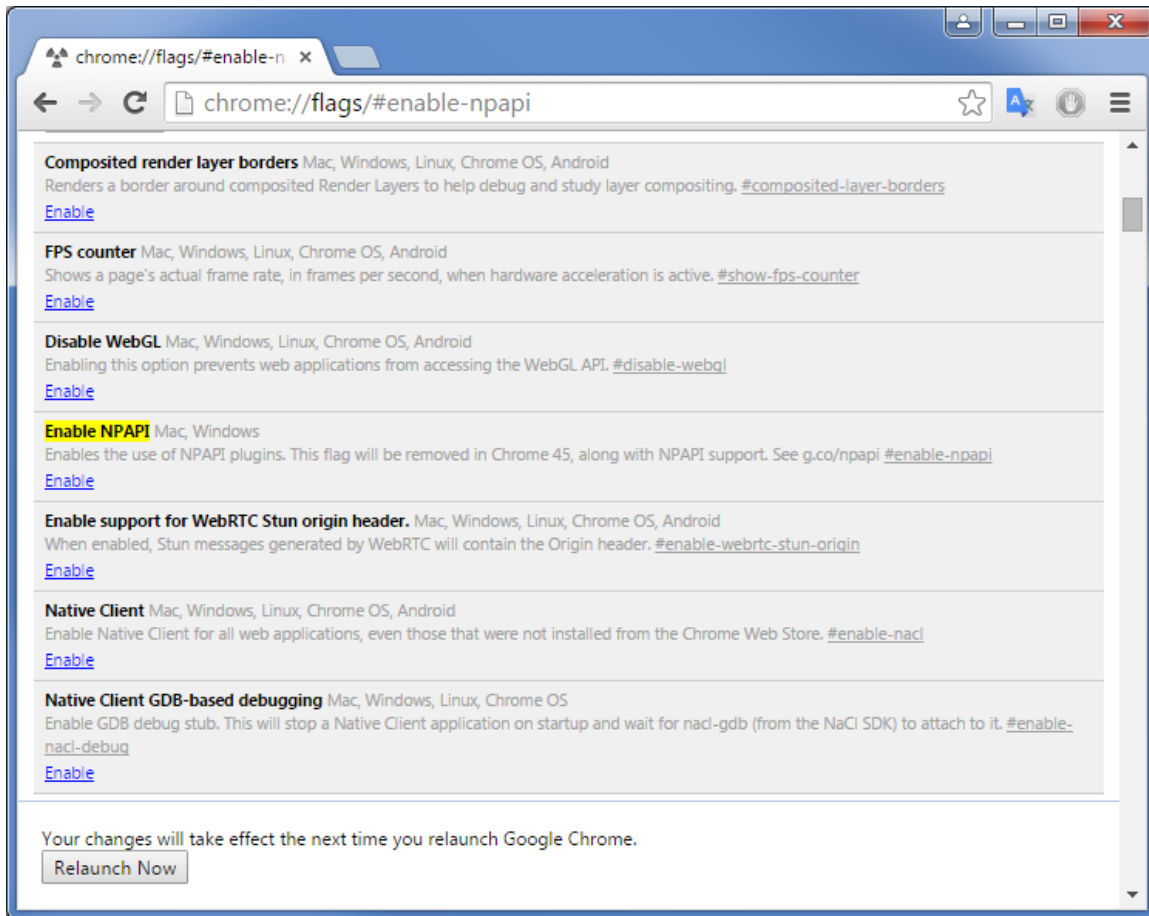

4. Click **Relaunch Now**.

 For Google Chrome version 45 and later, you will need to use an alternate web browser to load content that requires a NPAPI plugin.

## Configuring Java Exception to Open Virtual Appliance Console - Apple Mac OS X

en

 This procedure is available on version 1.2 of the firmware.

Complete the following steps to configure a Java security exception to allow you to open a console window for the virtual appliances in the Barracuda Security Suite. The console window can give you access to some of the underlying functionality and settings for the virtual appliances.

1. Open System Preferences.
2. Open the Java control panel and click the Security tab.

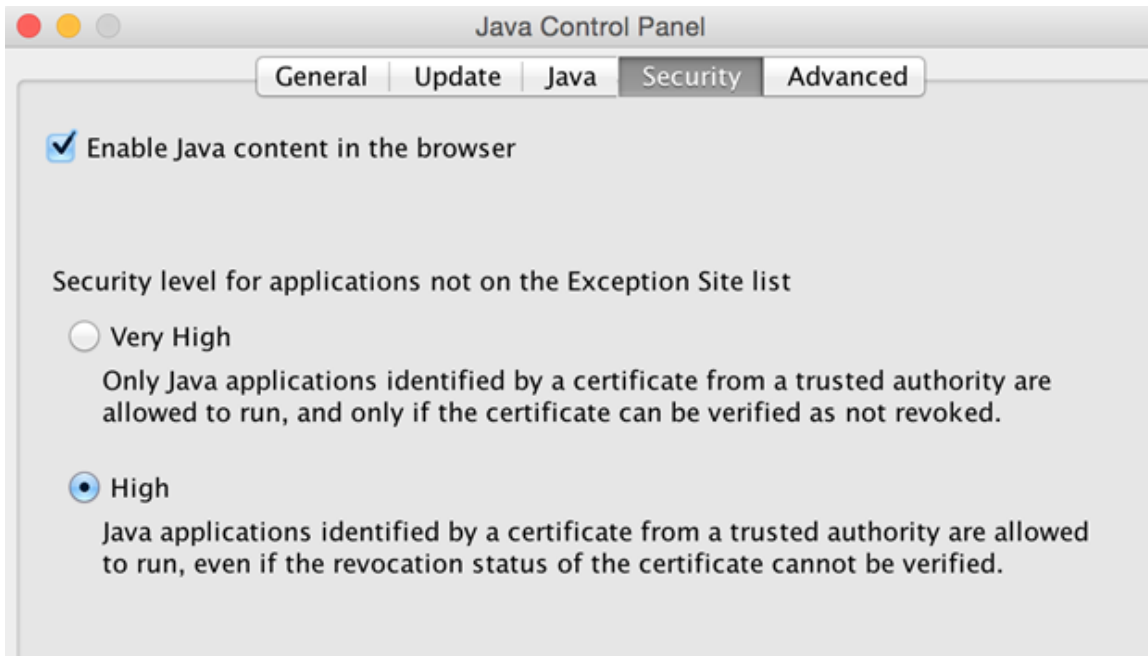

3. Set the security level to **High**.
4. Click **Edit Site List**.

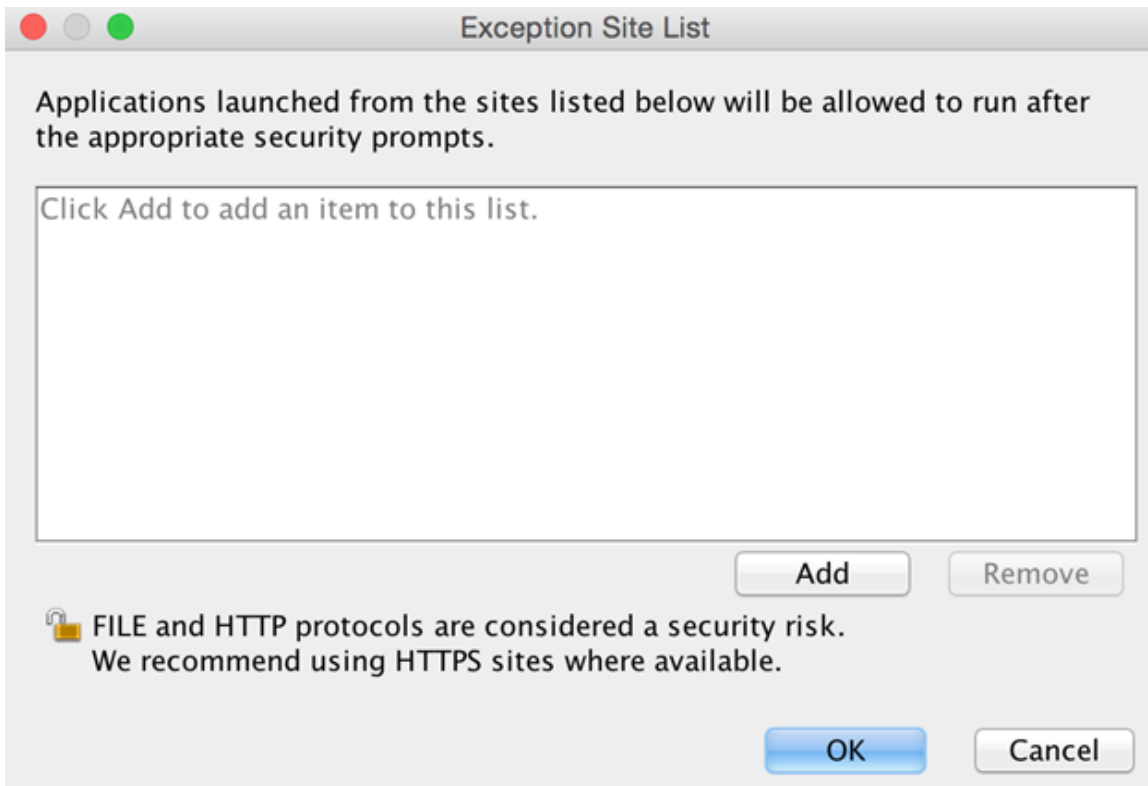

5. Click **Add**.
6. Enter the the following URL in the text input box: <http://172.16.31.254>

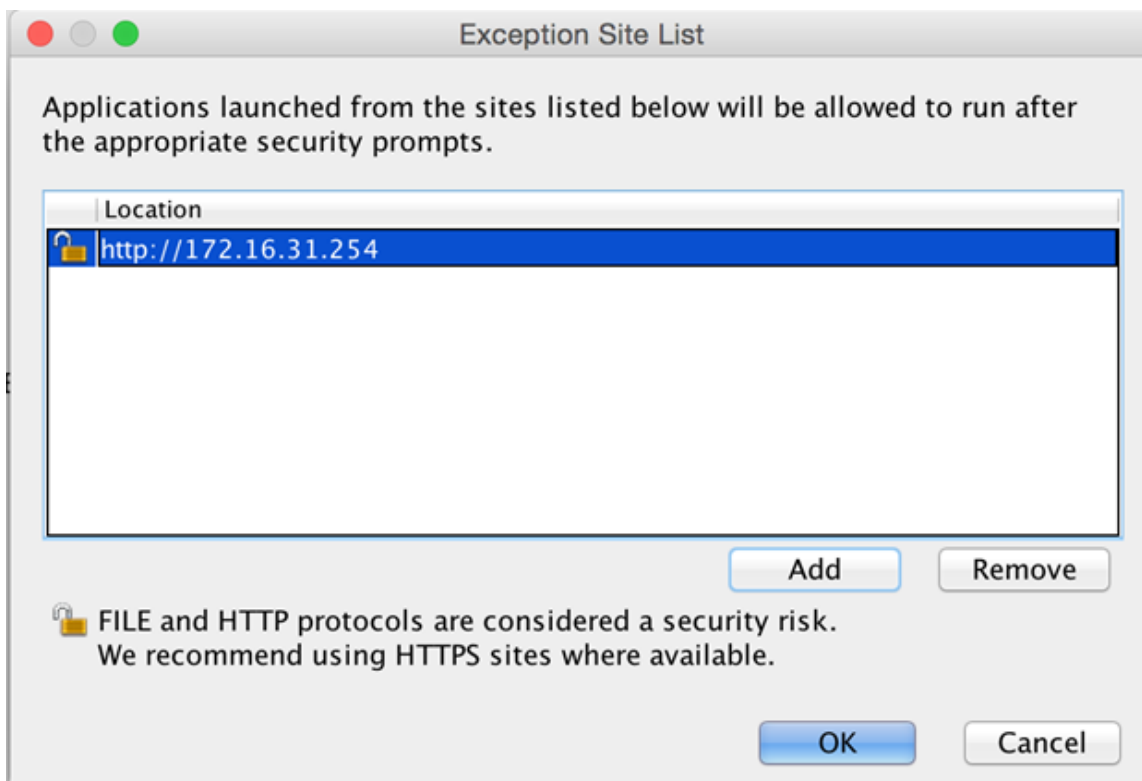

7. Click **Continue** on the Security Warning popup window.
8. From the Barracuda Security Suite user interface, click on the VNC terminal icon for the Barracuda Firewall. When the warning message appears, click **Run**.
9. In the VNC terminal window, click enter to get a command prompt.

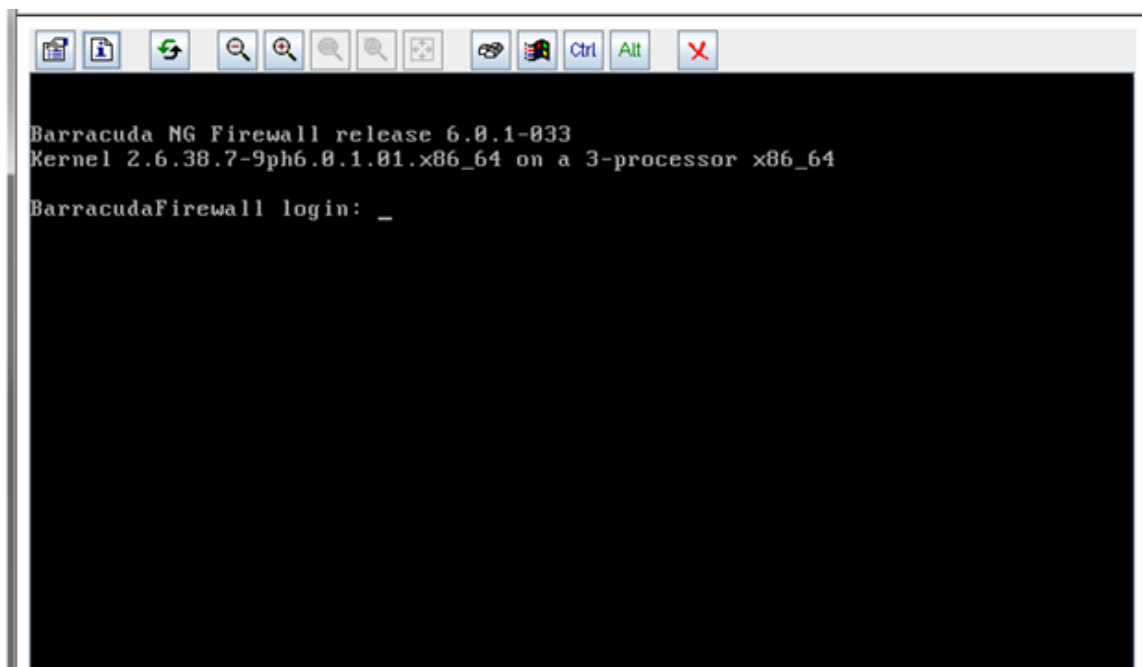

## Barracuda Security Suite Hardware Features

en

Front Panel

Barracuda Security Suite 300

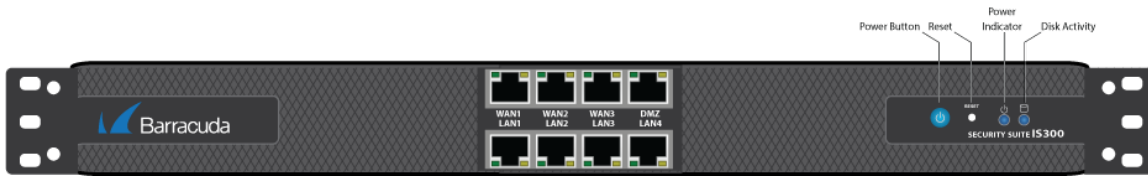

**Table 1. Barracuda Security Suite 300 front panel features.**

Label	Description
WAN1, WAN2, WAN3	Copper Ethernet ports for WAN connections.
DMZ	Copper Ethernet port for the DMZ.
LAN1, LAN2, LAN3, LAN4	Copper Ethernet ports for LAN connections.
Power Button	Turns the appliance on and off.
Reset Button	Resets the appliance.
Power Indicator	Displays a solid blue light while the appliance is turned on.
Disk Activity	Displays a blinking blue light during disk activity.

## Back Panel

### Barracuda Security Suite 300

**Table 2. Barracuda Security Suite 300 back panel features.**

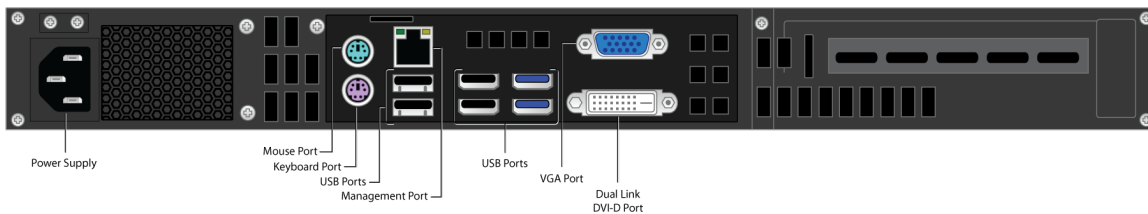

Label	Description
DVI-D (Dual Link) Port	DVI-D connection for a monitor.
Keyboard Port	PS/2 connection for the keyboard.
Mouse Port	PS/2 connection for the mouse.
Management Port	Ethernet port that is used as the management port.
Power Supply	Socket for the AC power cord; standard power supply.
USB Ports	Connections for USB devices.
VGA Port	VGA connection for a monitor.

## Limited Warranty and License

en

### Limited Warranty

Barracuda Networks, Inc., or the Barracuda Networks, Inc. subsidiary or authorized Distributor selling the Barracuda Networks product, if sale is not directly by Barracuda Networks, Inc., ("Barracuda Networks") warrants that commencing from the date of delivery to Customer (but in case of resale by a Barracuda Networks reseller, commencing not more than sixty (60) days after original shipment by Barracuda Networks, Inc.), and continuing for a period of one (1) year: (a) its products (excluding any software) will be free from material defects in materials and workmanship

under normal use; and (b) the software provided in connection with its products, including any software contained or embedded in such products will substantially conform to Barracuda Networks published specifications in effect as of the date of manufacture. Except for the foregoing, the software is provided as is. In no event does Barracuda Networks warrant that the software is error free or that Customer will be able to operate the software without problems or interruptions. In addition, due to the continual development of new techniques for intruding upon and attacking networks, Barracuda Networks does not warrant that the software or any equipment, system or network on which the software is used will be free of vulnerability to intrusion or attack. The limited warranty extends only to you the original buyer of the Barracuda Networks product and is non-transferable.

### **Exclusive Remedy**

Your sole and exclusive remedy and the entire liability of Barracuda Networks under this limited warranty shall be, at Barracuda Networks or its service centers option and expense, the repair, replacement or refund of the purchase price of any products sold which do not comply with this warranty. Hardware replaced under the terms of this limited warranty may be refurbished or new equipment substituted at Barracuda Networks option. Barracuda Networks obligations hereunder are conditioned upon the return of affected articles in accordance with Barracuda Networks then-current Return Material Authorization ("RMA") procedures. All parts will be new or refurbished, at Barracuda Networks discretion, and shall be furnished on an exchange basis. All parts removed for replacement will become the property of the Barracuda Networks. In connection with warranty services hereunder, Barracuda Networks may at its discretion modify the hardware of the product at no cost to you to improve its reliability or performance. The warranty period is not extended if Barracuda Networks repairs or replaces a warranted product or any parts. Barracuda Networks may change the availability of limited warranties, at its discretion, but any changes will not be retroactive. IN NO EVENT SHALL BARRACUDA NETWORKS LIABILITY EXCEED THE PRICE PAID FOR THE PRODUCT FROM DIRECT, INDIRECT, SPECIAL, INCIDENTAL, OR CONSEQUENTIAL DAMAGES RESULTING FROM THE USE OF THE PRODUCT, ITS ACCOMPANYING SOFTWARE, OR ITS DOCUMENTATION.

### **Exclusions and Restrictions**

This limited warranty does not apply to Barracuda Networks products that are or have been (a) marked or identified as "sample" or "beta," (b) loaned or provided to you at no cost, (c) sold "as is," (d) repaired, altered or modified except by Barracuda Networks, (e) not installed, operated or maintained in accordance with instructions supplied by Barracuda Networks, or (f) subjected to abnormal physical or electrical stress, misuse, negligence or to an accident.

EXCEPT FOR THE ABOVE WARRANTY, BARRACUDA NETWORKS MAKES NO OTHER WARRANTY, EXPRESS, IMPLIED OR STATUTORY, WITH RESPECT TO BARRACUDA NETWORKS PRODUCTS, INCLUDING WITHOUT LIMITATION ANY IMPLIED WARRANTY OF TITLE, AVAILABILITY, RELIABILITY, USEFULNESS, MERCHANTABILITY, FITNESS FOR A PARTICULAR PURPOSE, NONINFRINGEMENT, OR ARISING FROM COURSE OF PERFORMANCE, DEALING, USAGE OR TRADE. EXCEPT FOR THE ABOVE WARRANTY, BARRACUDA NETWORKS PRODUCTS AND THE SOFTWARE IS PROVIDED "AS IS" AND BARRACUDA NETWORKS DOES NOT WARRANT THAT ITS PRODUCTS WILL MEET YOUR REQUIREMENTS OR BE UNINTERRUPTED, TIMELY, AVAILABLE, SECURE OR ERROR-FREE, OR THAT ANY ERRORS IN ITS PRODUCTS OR THE SOFTWARE WILL BE CORRECTED. FURTHERMORE, BARRACUDA NETWORKS DOES NOT WARRANT THAT BARRACUDA NETWORKS PRODUCTS, THE SOFTWARE OR ANY EQUIPMENT, SYSTEM OR NETWORK ON WHICH BARRACUDA NETWORKS PRODUCTS WILL BE USED WILL BE FREE OF VULNERABILITY TO INTRUSION OR ATTACK.

### **Software License**

PLEASE READ THIS SOFTWARE LICENSE AGREEMENT ("AGREEMENT") CAREFULLY BEFORE USING THE BARRACUDA SOFTWARE. BY USING THE BARRACUDA SOFTWARE YOU ARE AGREEING TO BE BOUND BY THE TERMS OF THIS LICENSE. IF YOU DO NOT AGREE TO THE TERMS OF THIS LICENSE DO NOT USE THE SOFTWARE. IF YOU DO NOT AGREE TO THE TERMS OF THIS LICENSE YOU MAY RETURN THE SOFTWARE OR HARDWARE CONTAINING THE SOFTWARE FOR A FULL REFUND TO YOUR PLACE OF PURCHASE.

1. The software, documentation, whether on disk, in read only memory, or on any other media or in any other form (collectively "Barracuda Software") is licensed, not sold, to you by Barracuda Networks, Inc. ("Barracuda") for use only under the terms of this License and Barracuda reserves all rights not expressly granted to you. The rights granted are limited to Barracuda's intellectual property rights in the Barracuda Software and do not include any other patent or intellectual property rights. You own the media on which the Barracuda Software is recorded but Barracuda retains ownership of the Barracuda Software itself.
2. Permitted License Uses and Restrictions. This License allows you to use the Software only on the single Barracuda labeled hardware device on which the software was delivered. You may not make copies of the Software and you may not make the Software available over a network where it could be utilized by multiple devices or copied. You may not make a backup copy of the Software. You may not modify or create derivative works of the Software except as provided by the Open Source Licenses included below. The BARRACUDA SOFTWARE IS NOT INTENDED FOR USE IN THE OPERATION OF NUCLEAR FACILITIES, AIRCRAFT NAVIGATION OR COMMUNICATION SYSTEMS, LIFE SUPPORT MACHINES, OR OTHER EQUIPEMENT IN WHICH FAILURE COULD LEAD TO DEATH, PERSONAL INJURY, OR ENVIRONMENTAL DAMAGE.



3. You may not transfer, rent, lease, lend, or sublicense the Barracuda Software.

4. This License is effective until terminated. This License is automatically terminated without notice if you fail to comply with any term of the License. Upon termination you must destroy or return all copies of the Barracuda Software.

5. YOU EXPRESSLY ACKNOWLEDGE AND AGREE THAT THE USE OF THE BARRACUDA SOFTWARE IS AT YOUR OWN RISK AND THAT THE ENTIRE RISK AS TO SATISFACTION, QUALITY, PERFORMANCE, AND ACCURACY IS WITH YOU. THE BARRACUDA SOFTWARE IS PROVIDED "AS IS" WITH ALL FAULTS AND WITHOUT WARRANTY OF ANY KIND, AND BARRACUDA HEREBY DISCLAIMS ALL WARRANTIES AND CONDITIONS WITH RESPECT TO THE BARRACUDA SOFTWARE, EITHER EXPRESSED OR IMPLIED OR STATUTORY, INCLUDING, BUT NOT LIMITED TO, THE IMPLIED WARRANTIES AND/OR CONDITIONS OF MERCHANTABILITY, OF SATISFACTORY QUALITY, OF FITNESS FOR ANY APPLICATION, OF ACCURACY, AND OF NON-INFRINGEMENT OF THIRD PARTY RIGHTS. BARRACUDA DOES NOT WARRANT THE CONTINUED OPERATION OF THE SOFTWARE, THAT THE PERFORMANCE WILL MEET YOUR EXPECTATIONS, THAT THE FUNCTIONS WILL MEET YOUR REQUIREMENTS, THAT THE OPERATION WILL BE ERROR FREE OR CONTINUOUS, OR THAT DEFECTS WILL BE CORRECTED. NO ORAL OR WRITTEN INFORMATION GIVEN BY BARRACUDA OR AUTHORIZED BARRACUDA REPRESENTATIVE SHALL CREATE A WARRANTY. SHOULD THE BARRACUDA SOFTWARE PROVE DEFECTIVE, YOU ASSUME THE ENTIRE COST OF ALL NECESSARY SERVICING, REPAIR, OR CORRECTION.

6. License. YOU EXPRESSLY ACKNOWLEDGE AND AGREE THAT YOU WILL PROVIDE AN UNLIMITED ZERO COST LICENSE TO BARRACUDA FOR ANY PATENTS OR OTHER INTELLECTUAL PROPERTY RIGHTS UTILIZED IN THE BARRACUDA SOFTWARE WHICH YOU EITHER OWN OR CONTROL.

7. Limitation of Liability. TO THE EXTENT NOT PROHIBITED BY LAW, IN NO EVENT SHALL BARRACUDA BE LIABLE FOR PERSONAL INJURY OR ANY INCIDENTAL SPECIAL, INDIRECT, OR CONSEQUENTIAL DAMAGES WHATSOEVER, INCLUDING, WITHOUT LIMITATION, DAMAGES FOR LOSS OF PROFITS, LOSS OF DATA, BUSINESS INTERRUPTION, OR ANY OTHER COMMERCIAL DAMAGES OR LOSSES, ARISING OUT OF OR RELATED TO YOUR ABILITY TO USE OR INABILITY TO USE THE BARRACUDA SOFTWARE HOWEVER CAUSED, REGARDLESS OF THE THEORY OF LIABILITY AND EVEN IF BARRACUDA HAS BEEN ADVISED OF THE POSSIBILITY OF DAMAGES. In no event shall Barracuda's total liability to you for all damages exceed the amount of one hundred dollars.

8. Export Control. You may not use or otherwise export or re-export Barracuda Software except as authorized by the United States law and the laws of the jurisdiction where the Barracuda Software was obtained.

### **Energize Update Software License**

PLEASE READ THIS ENERGIZE UPDATE SOFTWARE LICENSE CAREFULLY BEFORE DOWNLOADING, INSTALLING OR USING BARRACUDA NETWORKS OR BARRACUDA NETWORKS-SUPPLIED ENERGIZE UPDATE SOFTWARE.

BY DOWNLOADING OR INSTALLING THE ENERGIZE UPDATE SOFTWARE, OR USING THE EQUIPMENT THAT CONTAINS THIS SOFTWARE, YOU ARE CONSENTING TO BE BOUND BY THIS LICENSE. IF YOU DO NOT AGREE TO ALL OF THE TERMS OF THIS LICENSE, THEN (A) DO NOT DOWNLOAD, INSTALL OR USE THE SOFTWARE, AND (B) YOU MAY RETURN THE SOFTWARE FOR A FULL REFUND, OR, IF THE SOFTWARE IS SUPPLIED AS PART OF ANOTHER PRODUCT, YOU MAY RETURN THE ENTIRE PRODUCT FOR A FULL REFUND. YOUR RIGHT TO RETURN AND REFUND EXPIRES 30 DAYS AFTER PURCHASE FROM BARRACUDA NETWORKS OR AN AUTHORIZED BARRACUDA NETWORKS RESELLER, AND APPLIES ONLY IF YOU ARE THE ORIGINAL PURCHASER.

The following terms govern your use of the Energize Update Software except to the extent a particular program (a) is the subject of a separate written agreement with Barracuda Networks or (b) includes a separate "click-on" license agreement as part of the installation and/or download process. To the extent of a conflict between the provisions of the foregoing documents, the order of precedence shall be (1) the written agreement, (2) the click-on agreement, and (3) this Energize Update Software License.

License. Subject to the terms and conditions of and except as otherwise provided in this Agreement, Barracuda Networks, Inc., or a Barracuda Networks, Inc. subsidiary (collectively "Barracuda Networks"), grants to the end-user ("Customer") a nonexclusive and nontransferable license to use the Barracuda Networks Energize Update program modules and data files for which Customer has paid the required license fees (the "Energize Update Software"). In addition, the foregoing license shall also be subject to the following limitations, as applicable:

Unless otherwise expressly provided in the documentation, Customer shall use the Energize Update Software solely as embedded in, for execution on, or (where the applicable documentation permits installation on non-Barracuda Networks equipment) for communication with Barracuda Networks equipment owned or leased by Customer; Customer's use of the Energize Update Software shall be limited to use on a single hardware chassis, on a single central processing unit, as applicable, or use on such greater number of chassis or central processing units as Customer may have paid Barracuda Networks the required license fee; and Customer's use of the Energize Update Software shall also be limited, as applicable and set forth in Customer's purchase order or in Barracuda Networks' product catalog, user documentation, or web site, to a maximum number of (a) seats (i.e. users with access to the installed Energize Update Software), (b) concurrent users, sessions, ports, and/or issued and outstanding IP addresses, and/or (c) central processing unit cycles or instructions per second. Customer's use of the Energize Update Software shall also be limited by any other restrictions set forth in Customer's purchase order or in Barracuda Networks' product catalog, user documentation or web site for the Energize Update Software.

General Limitations. Except as otherwise expressly provided under this Agreement, Customer shall have no right, and Customer specifically agrees not to:

1. a. transfer, assign or sublicense its license rights to any other person, or use the Energize Update Software on unauthorized or secondhand Barracuda Networks equipment, and any such attempted transfer, assignment or sublicense shall be void;
- b. make error corrections to or otherwise modify or adapt the Energize Update Software or create derivative works based upon the Energize Update Software, or to permit third parties to do the same; or
- c. decompile, decrypt, reverse engineer, disassemble or otherwise reduce the Energize Update Software to human-readable form to gain access to trade secrets or confidential information in the Energize Update Software.

Upgrades and Additional Copies. For purposes of this Agreement, "Energize Update Software" shall include (and the terms and conditions of this Agreement shall apply to) any Energize Update upgrades, updates, bug fixes or modified versions (collectively, "Upgrades") or backup copies of the Energize Update Software licensed or provided to Customer by Barracuda Networks or an authorized distributor/reseller for which Customer has paid the applicable license fees. NOTWITHSTANDING ANY OTHER PROVISION OF THIS AGREEMENT: (1) CUSTOMER HAS NO LICENSE OR RIGHT TO USE ANY SUCH ADDITIONAL COPIES OR UPGRADES UNLESS CUSTOMER, AT THE TIME OF ACQUIRING SUCH COPY OR UPGRADE, ALREADY HOLDS A VALID LICENSE TO THE ORIGINAL ENERGIZE UPDATE SOFTWARE AND HAS PAID THE APPLICABLE FEE FOR THE UPGRADE; (2) USE OF UPGRADES IS LIMITED TO BARRACUDA NETWORKS EQUIPMENT FOR WHICH CUSTOMER IS THE ORIGINAL END USER PURCHASER OR LESSEE OR WHO OTHERWISE HOLDS A VALID LICENSE TO USE THE ENERGIZE UPDATE SOFTWARE WHICH IS BEING UPGRADED; AND (3) USE OF ADDITIONAL COPIES IS LIMITED TO BACKUP PURPOSES ONLY.

Energize Update Changes. Barracuda Networks reserves the right at any time not to release or to discontinue release of any Energize Update Software and to alter prices, features, specifications, capabilities, functions, licensing terms, release dates, general availability or other characteristics of any future releases of the Energize Update Software.

Proprietary Notices. Customer agrees to maintain and reproduce all copyright and other proprietary notices on all copies, in any form, of the Energize Update Software in the same form and manner that such copyright and other proprietary notices are included on the Energize Update Software. Except as expressly authorized in this Agreement, Customer shall not make any copies or duplicates of any Energize Update Software without the prior written permission of Barracuda Networks. Customer may make such backup copies of the Energize Update Software as may be necessary for Customer's lawful use, provided Customer affixes to such copies all copyright, confidentiality, and proprietary notices that appear on the original.

Protection of Information. Customer agrees that aspects of the Energize Update Software and associated documentation, including the specific design and structure of individual programs, constitute trade secrets and/or copyrighted material of Barracuda Networks. Customer shall not disclose, provide, or otherwise make available such trade secrets or copyrighted material in any form to any third party without the prior written consent of Barracuda Networks. Customer shall implement reasonable security measures to protect and maintain the confidentiality of such trade secrets and copyrighted material. Title to Energize Update Software and documentation shall remain solely with Barracuda Networks.

Indemnity. Customer agrees to indemnify, hold harmless and defend Barracuda Networks and its affiliates, subsidiaries, officers, directors, employees and agents at Customer's expense, against any and all third-party claims, actions, proceedings, and suits and all related liabilities, damages, settlements, penalties, fines, costs and expenses (including, without limitation, reasonable attorneys fees and other dispute resolution expenses) incurred by Barracuda Networks arising out of or relating to Customer's (a) violation or breach of any term of this Agreement or any policy or guidelines referenced herein, or (b) use or misuse of the Barracuda Networks Energize Update Software.

Term and Termination. This License is effective upon date of delivery to Customer of the initial Energize Update Software (but in case of resale by a Barracuda Networks distributor or reseller, commencing not more than sixty (60) days after original Energize Update Software purchase from Barracuda Networks) and continues for the period for which Customer has paid the required license fees. Customer may terminate this License at any time by notifying Barracuda Networks and ceasing all use of the Energize Update Software. By terminating this License, Customer forfeits any refund of license fees paid and is responsible for paying any and all outstanding invoices. Customer's rights under this License will terminate immediately without notice from Barracuda Networks if Customer fails to comply with any provision of this License. Upon termination, Customer must cease use of all copies of Energize Update Software in its possession or control.

Export. Software, including technical data, may be subject to U.S. export control laws, including the U.S. Export Administration Act and its associated regulations, and may be subject to export or import regulations in other countries. Customer agrees to comply strictly with all such regulations and acknowledges that it has the responsibility to obtain licenses to export, re-export, or import Energize Update Software.

Restricted Rights. Barracuda Networks' commercial software and commercial computer software documentation is provided to United States Government agencies in accordance with the terms of this Agreement, and per subparagraph "(c)" of the "Commercial Computer Software - Restricted Rights" clause at FAR 52.227-19 (June 1987). For DOD agencies, the restrictions set forth in the "Technical Data-Commercial Items" clause at DFARS 252.227-7015 (Nov 1995) shall also apply.

No Warranty. The Energize Update Software is provided AS IS. Customer's sole and exclusive remedy and the entire liability of Barracuda Networks under this Energize Update Software License Agreement will be, at Barracuda Networks option, repair, replacement, or refund of the Energize Update Software.

Renewal. At the end of the Energize Update Service Period, Customer may have the option to renew the Energize Update Service at the current list price, provided such Energize Update Service is available. All initial subscriptions commence at the time of sale of the unit and all renewals commence at the expiration of the previous valid subscription.

In no event does Barracuda Networks warrant that the Energize Update Software is error free or that Customer will be able to operate the Energize Update Software without problems or interruptions. In addition, due to the continual development of new techniques for intruding upon and attacking networks, Barracuda Networks does not warrant that the Energize Update Software or any equipment, system or network on which the Energize Update Software is used will be free of vulnerability to intrusion or attack.

DISCLAIMER OF WARRANTY. ALL EXPRESS OR IMPLIED CONDITIONS, REPRESENTATIONS, AND WARRANTIES INCLUDING, WITHOUT LIMITATION, ANY IMPLIED WARRANTY OR CONDITION OF MERCHANTABILITY, FITNESS FOR A PARTICULAR PURPOSE, NONINFRINGEMENT, SATISFACTORY QUALITY OR ARISING FROM A COURSE OF DEALING, LAW, USAGE, OR TRADE PRACTICE, ARE HEREBY EXCLUDED TO THE EXTENT ALLOWED BY APPLICABLE LAW. TO THE EXTENT AN IMPLIED WARRANTY CANNOT BE EXCLUDED, SUCH WARRANTY IS LIMITED IN DURATION TO THE WARRANTY PERIOD. BECAUSE SOME STATES OR JURISDICTIONS DO NOT ALLOW LIMITATIONS ON HOW LONG AN IMPLIED WARRANTY LASTS, THE ABOVE LIMITATION MAY NOT APPLY TO YOU. THIS WARRANTY GIVES YOU SPECIFIC LEGAL RIGHTS, AND YOU MAY ALSO HAVE OTHER RIGHTS WHICH VARY FROM JURISDICTION TO JURISDICTION.

General Terms Applicable to the Energize Update Software License Disclaimer of Liabilities. IN NO EVENT WILL BARRACUDA NETWORKS BE LIABLE FOR ANY LOST REVENUE, PROFIT, OR DATA, OR FOR SPECIAL, INDIRECT, CONSEQUENTIAL, INCIDENTAL, OR PUNITIVE DAMAGES HOWEVER CAUSED AND REGARDLESS OF THE THEORY OF LIABILITY ARISING OUT OF THE USE OF OR INABILITY TO USE THE ENERGIZE UPDATE SOFTWARE EVEN IF BARRACUDA NETWORKS OR ITS SUPPLIERS HAVE BEEN ADVISED OF THE POSSIBILITY OF SUCH DAMAGES. In no event shall Barracuda Networks' liability to Customer, whether in contract, tort (including negligence), or otherwise, exceed the price paid by Customer. BECAUSE SOME STATES OR JURISDICTIONS DO NOT ALLOW LIMITATION OR EXCLUSION OF CONSEQUENTIAL OR INCIDENTAL DAMAGES, THE ABOVE LIMITATION MAY NOT APPLY TO YOU.

This Energize Update Software License shall be governed by and construed in accordance with the laws of the State of California, without reference to principles of conflict of laws, provided that for Customers located in a member state of the European Union, Norway or Switzerland, English law shall apply. The United Nations Convention on the International Sale of Goods shall not apply. If any portion hereof is found to be void or unenforceable, the remaining provisions of the Energize Update Software License shall remain in full force and effect. Except as expressly provided herein, the Energize Update Software License constitutes the entire agreement between the parties with respect to the license of the Energize Update Software and supersedes any conflicting or additional terms contained in the purchase order.

## Open Source Licensing

Barracuda products may include programs that are covered by the GNU General Public License (GPL) or other "open source" license agreements. The GNU license is re-printed below for your reference. These programs are copyrighted by their authors or other parties, and the authors and copyright holders disclaim any warranty for such programs. Other programs are copyright by Barracuda Networks.

GNU GENERAL PUBLIC LICENSE, (GPL) Version 2, June 1991

Copyright (C) 1989, 1991 Free Software Foundation, Inc. 51 Franklin St, Fifth Floor, Boston, MA 02110-1301 USA

Everyone is permitted to copy and distribute verbatim copies of this license document, but changing it is not allowed.

### Preamble

The licenses for most software are designed to take away your freedom to share and change it. By contrast, the GNU General Public

License is intended to guarantee your freedom to share and change free software--to make sure the software is free for all its users. This General Public License applies to most of the Free Software Foundation's software and to any other program whose authors commit to using it. (Some other Free Software Foundation software is covered by the GNU Library General Public License instead.) You can apply it to your programs, too.

When we speak of free software, we are referring to freedom, not price. Our General Public Licenses are designed to make sure that you have the freedom to distribute copies of free software (and charge for this service if you wish), that you receive source code or can get it if you want it, that you can change the software or use pieces of it in new free programs; and that you know you can do these things.

To protect your rights, we need to make restrictions that forbid anyone to deny you these rights or to ask you to surrender the rights. These restrictions translate to certain responsibilities for you if you distribute copies of the software, or if you modify it.

For example, if you distribute copies of such a program, whether gratis or for a fee, you must give the recipients all the rights that you have. You must make sure that they, too, receive or can get the source code. And you must show them these terms so they know their rights.

We protect your rights with two steps: (1) copyright the software, and (2) offer you this license which gives you legal permission to copy, distribute and/or modify the software.

Also, for each author's protection and ours, we want to make certain that everyone understands that there is no warranty for this free software. If the software is modified by someone else and passed on, we want its recipients to know that what they have is not the original, so that any problems introduced by others will not reflect on the original authors' reputations.

Finally, any free program is threatened constantly by software patents. We wish to avoid the danger that redistributors of a free program will individually obtain patent licenses, in effect making the program proprietary. To prevent this, we have made it clear that any patent must be licensed for everyone's free use or not licensed at all.

The precise terms and conditions for copying, distribution and modification follow.

## **GNU GENERAL PUBLIC LICENSE TERMS AND CONDITIONS FOR COPYING, DISTRIBUTION AND MODIFICATION**

0. This License applies to any program or other work which contains a notice placed by the copyright holder saying it may be distributed under the terms of this General Public License. The "Program", below, refers to any such program or work, and a "work based on the Program" means either the Program or any derivative work under copyright law: that is to say, a work containing the Program or a portion of it, either verbatim or with modifications and/or translated into another language. (Hereinafter, translation is included without limitation in the term "modification".) Each licensee is addressed as "you".

Activities other than copying, distribution and modification are not covered by this License; they are outside its scope. The act of running the Program is not restricted, and the output from the Program is covered only if its contents constitute a work based on the Program (independent of having been made by running the Program). Whether that is true depends on what the Program does.

1. You may copy and distribute verbatim copies of the Program's source code as you receive it, in any medium, provided that you conspicuously and appropriately publish on each copy an appropriate copyright notice and disclaimer of warranty; keep intact all the notices that refer to this License and to the absence of any warranty; and give any other recipients of the Program a copy of this License along with the Program.

You may charge a fee for the physical act of transferring a copy, and you may at your option offer warranty protection in exchange for a fee.

2. You may modify your copy or copies of the Program or any portion of it, thus forming a work based on the Program, and copy and distribute such modifications or work under the terms of Section 1 above, provided that you also meet all of these conditions:

- a) You must cause the modified files to carry prominent notices stating that you changed the files and the date of any change.
- b) You must cause any work that you distribute or publish, that in whole or in part contains or is derived from the Program or any part thereof, to be licensed as a whole at no charge to all third parties under the terms of this License.
- c) If the modified program normally reads commands interactively when run, you must cause it, when started running for such interactive use in the most ordinary way, to print or display an announcement including an appropriate copyright notice and a notice that there is no warranty (or else, saying that you provide a warranty) and that users may redistribute the program under these conditions, and telling the user how to view a copy of this License. (Exception: if the Program itself is interactive but does not normally print such an announcement, your work based on the Program is not required to print an announcement.)

These requirements apply to the modified work as a whole. If identifiable sections of that work are not derived from the Program, and can be reasonably considered independent and separate works in themselves, then this License, and its terms, do not apply to those sections when you distribute them as separate works. But when you distribute the same sections as part of a whole which is a work based on the Program, the distribution of the whole must be on the terms of this License, whose permissions for other licensees extend to the entire whole, and thus to each and every part regardless of who wrote it.

Thus, it is not the intent of this section to claim rights or contest your rights to work written entirely by you; rather, the intent is to exercise the right to control the distribution of derivative or collective works based on the Program.

In addition, mere aggregation of another work not based on the Program with the Program (or with a work based on the Program) on a volume of a storage or distribution medium does not bring the other work under the scope of this License.

3. You may copy and distribute the Program (or a work based on it, under Section 2) in object code or executable form under the terms of Sections 1 and 2 above provided that you also do one of the following:

- a) Accompany it with the complete corresponding machine-readable source code, which must be distributed under the terms of Sections 1 and 2 above on a medium customarily used for software interchange; or,
- b) Accompany it with a written offer, valid for at least three years, to give any third party, for a charge no more than your cost of physically performing source distribution, a complete machine-readable copy of the corresponding source code, to be distributed under the terms of Sections 1 and 2 above on a medium customarily used for software interchange; or,
- c) Accompany it with the information you received as to the offer to distribute corresponding source code. (This alternative is allowed only for noncommercial distribution and only if you received the program in object code or executable form with such an offer, in accord with Subsection b above.)

The source code for a work means the preferred form of the work for making modifications to it. For an executable work, complete source code means all the source code for all modules it contains, plus any associated interface definition files, plus the scripts used to control compilation and installation of the executable. However, as a special exception, the source code distributed need not include anything that is normally distributed (in either source or binary form) with the major components (compiler, kernel, and so on) of the operating system on which the executable runs, unless that component itself accompanies the executable.

If distribution of executable or object code is made by offering access to copy from a designated place, then offering equivalent access to copy the source code from the same place counts as distribution of the source code, even though third parties are not compelled to copy the source along with the object code.

4. You may not copy, modify, sublicense, or distribute the Program except as expressly provided under this License. Any attempt otherwise to copy, modify, sublicense or distribute the Program is void, and will automatically terminate your rights under this License. However, parties who have received copies, or rights, from you under this License will not have their licenses terminated so long as such parties remain in full compliance.

5. You are not required to accept this License, since you have not signed it. However, nothing else grants you permission to modify or distribute the Program or its derivative works. These actions are prohibited by law if you do not accept this License. Therefore, by modifying or distributing the Program (or any work based on the Program), you indicate your acceptance of this License to do so, and all its terms and conditions for copying, distributing or modifying the Program or works based on it.

6. Each time you redistribute the Program (or any work based on the Program), the recipient automatically receives a license from the original licensor to copy, distribute or modify the Program subject to these terms and conditions. You may not impose any further restrictions on the recipients' exercise of the rights granted herein. You are not responsible for enforcing compliance by third parties to this License.

7. If, as a consequence of a court judgment or allegation of patent infringement or for any other reason (not limited to patent issues), conditions are imposed on you (whether by court order, agreement or otherwise) that contradict the conditions of this License, they do not excuse you from the conditions of this License. If you cannot distribute so as to satisfy simultaneously your obligations under this License and any other pertinent obligations, then as a consequence you may not distribute the Program at all. For example, if a patent license would not permit royalty-free redistribution of the Program by all those who receive copies directly or indirectly through you, then the only way you could satisfy both it and this License would be to refrain entirely from distribution of the Program.

If any portion of this section is held invalid or unenforceable under any particular circumstance, the balance of the section is intended to apply and the section as a whole is intended to apply in other circumstances.

It is not the purpose of this section to induce you to infringe any patents or other property right claims or to contest validity of any such claims; this section has the sole purpose of protecting the integrity of the free software distribution system, which is implemented by public license practices. Many people have made generous contributions to the wide range of software distributed through that system in reliance on consistent application of that system; it is up to the author/donor to decide if he or she is willing to distribute software through any other system and a licensee cannot impose that choice.

This section is intended to make thoroughly clear what is believed to be a consequence of the rest of this License.

8. If the distribution and/or use of the Program is restricted in certain countries either by patents or by copyrighted interfaces, the original copyright holder who places the Program under this License may add an explicit geographical distribution limitation excluding those countries, so that distribution is permitted only in or among countries not thus excluded. In such case, this License incorporates the limitation as if written in the body of this License.

9. The Free Software Foundation may publish revised and/or new versions of the General Public License from time to time. Such new versions will be similar in spirit to the present version, but may differ in detail to address new problems or concerns.

Each version is given a distinguishing version number. If the Program specifies a version number of this License which applies to it and "any later version", you have the option of following the terms and conditions either of that version or of any later version published by the Free Software Foundation. If the Program does not specify a version number of this License, you may choose any version ever published by the Free Software Foundation.

10. If you wish to incorporate parts of the Program into other free programs whose distribution conditions are different, write to the author to ask for permission. For software which is copyrighted by the Free Software Foundation, write to the Free Software Foundation; we sometimes make exceptions for this. Our decision will be guided by the two goals of preserving the free status of all derivatives of our free software and of promoting the sharing and reuse of software generally.

## **NO WARRANTY**

11. BECAUSE THE PROGRAM IS LICENSED FREE OF CHARGE, THERE IS NO WARRANTY FOR THE PROGRAM, TO THE EXTENT PERMITTED BY APPLICABLE LAW. EXCEPT WHEN OTHERWISE STATED IN WRITING THE COPYRIGHT HOLDERS AND/OR OTHER PARTIES PROVIDE THE PROGRAM "AS IS" WITHOUT WARRANTY OF ANY KIND, EITHER EXPRESSED OR IMPLIED, INCLUDING, BUT

NOT LIMITED TO, THE IMPLIED WARRANTIES OF MERCHANTABILITY AND FITNESS FOR A PARTICULAR PURPOSE. THE ENTIRE RISK AS TO THE QUALITY AND PERFORMANCE OF THE PROGRAM IS WITH YOU. SHOULD THE PROGRAM PROVE DEFECTIVE, YOU ASSUME THE COST OF ALL NECESSARY SERVICING, REPAIR OR CORRECTION.

12. IN NO EVENT UNLESS REQUIRED BY APPLICABLE LAW OR AGREED TO IN WRITING WILL ANY COPYRIGHT HOLDER, OR ANY OTHER PARTY WHO MAY MODIFY AND/OR REDISTRIBUTE THE PROGRAM AS PERMITTED ABOVE, BE LIABLE TO YOU FOR DAMAGES, INCLUDING ANY GENERAL, SPECIAL, INCIDENTAL OR CONSEQUENTIAL DAMAGES ARISING OUT OF THE USE OR INABILITY TO USE THE PROGRAM (INCLUDING BUT NOT LIMITED TO LOSS OF DATA OR DATA BEING RENDERED INACCURATE OR LOSSES SUSTAINED BY YOU OR THIRD PARTIES OR A FAILURE OF THE PROGRAM TO OPERATE WITH ANY OTHER PROGRAMS), EVEN IF SUCH HOLDER OR OTHER PARTY HAS BEEN ADVISED OF THE POSSIBILITY OF SUCH DAMAGES.

## END OF TERMS AND CONDITIONS

### How to Apply These Terms to Your New Programs

If you develop a new program, and you want it to be of the greatest possible use to the public, the best way to achieve this is to make it free software which everyone can redistribute and change under these terms.

To do so, attach the following notices to the program. It is safest to attach them to the start of each source file to most effectively convey the exclusion of warranty; and each file should have at least the "copyright" line and a pointer to where the full notice is found.

one line to give the program's name and an idea of what it does.

Copyright (C) yyyy name of author

This program is free software; you can redistribute it and/or modify it under the terms of the GNU General Public License as published by the Free Software Foundation; either version 2 of the License, or (at your option) any later version.

This program is distributed in the hope that it will be useful, but WITHOUT ANY WARRANTY; without even the implied warranty of MERCHANTABILITY or FITNESS FOR A PARTICULAR PURPOSE. See the GNU General Public License for more details.

You should have received a copy of the GNU General Public License along with this program; if not, write to the Free Software Foundation, Inc., 59 Temple Place - Suite 330, Boston, MA 02111-1307, USA.

Also add information on how to contact you by electronic and paper mail.

If the program is interactive, make it output a short notice like this when it starts in an interactive mode:

Gnomovision version 69, Copyright (C) 19yy name of author Gnomovision comes with ABSOLUTELY NO WARRANTY; for details type `show w'. This is free software, and you are welcome to redistribute it under certain conditions; type `show c' for details.

The hypothetical commands `show w' and `show c' should show the appropriate parts of the General Public License. Of course, the commands you use may be called something other than `show w' and `show c'; they could even be mouse-clicks or menu items--whatever suits your program.

You should also get your employer (if you work as a programmer) or your school, if any, to sign a "copyright disclaimer" for the program, if necessary. Here is a sample; alter the names:

Yoyodyne, Inc., hereby disclaims all copyright interest in the program `Gnomovision' (which makes passes at compilers) written by James Hacker.

signature of Ty Coon, 1 April 1989

Ty Coon, President of Vice

This General Public License does not permit incorporating your program into proprietary programs. If your program is a subroutine library, you may consider it more useful to permit linking proprietary applications with the library. If this is what you want to do, use the GNU Library General Public License instead of this License.

Barracuda Products may contain programs that are copyright (c)1995-2005 International Business Machines Corporation and others. All rights reserved. These programs are covered by the following License:

"Permission is hereby granted, free of charge, to any person obtaining a copy of this software and associated documentation files (the "Software"), to deal in the Software without restriction, including without limitation the rights to use, copy, modify, merge, publish, distribute, and/or sell copies of the Software, and to permit persons to whom the Software is furnished to do so, provided that the above copyright notice(s) and this permission notice appear in all copies of the Software and that both the above copyright notice(s) and this permission notice appear in supporting documentation."

Barracuda Products may include programs that are covered by the BSD License: "Redistribution and use in source and binary forms, with or without modification, are permitted provided that the following conditions are met:

Redistributions of source code must retain the above copyright notice, this list of conditions and the following disclaimer.

Redistributions in binary form must reproduce the above copyright notice, this list of conditions and the following disclaimer in the documentation and/or other materials provided with the distribution.

The names of the authors may not be used to endorse or promote products derived from this software without specific prior written permission.

THIS SOFTWARE IS PROVIDED ``AS IS'' AND WITHOUT ANY EXPRESS OR IMPLIED WARRANTIES, INCLUDING, WITHOUT LIMITATION, THE IMPLIED WARRANTIES OF MERCHANTABILITY AND FITNESS FOR A PARTICULAR PURPOSE."

Barracuda Products may include the libspf library which is Copyright (c) 2004 James Couzens & Sean Comeau All rights reserved. It is covered by the following agreement: Redistribution and use in source and binary forms, with or without modification, are permitted provided that the following conditions are met: 1. Redistributions of source code must retain the above copyright notice, this list of conditions and the following disclaimer. 2. Redistributions in binary form must reproduce the above copyright notice, this list of conditions and the following disclaimer in the documentation and/or other materials provided with the distribution. THIS SOFTWARE IS PROVIDED ``AS IS'' AND ANY EXPRESSED OR IMPLIED WARRANTIES, INCLUDING, BUT NOT LIMITED TO, THE IMPLIED WARRANTIES OF MERCHANTABILITY AND FITNESS FOR A PARTICULAR PURPOSE ARE DISCLAIMED. IN NO EVENT SHALL THE AUTHORS MAKING USE OF THIS LICENSE OR ITS CONTRIBUTORS BE LIABLE FOR ANY DIRECT, INDIRECT, INCIDENTAL, SPECIAL, EXEMPLARY, OR CONSEQUENTIAL DAMAGES (INCLUDING, BUT NOT LIMITED TO, PROCUREMENT OF SUBSTITUTE GOODS OR SERVICES; LOSS OF USE, DATA, OR PROFITS; OR BUSINESS INTERRUPTION) HOWEVER CAUSED AND ON ANY THEORY OF LIABILITY, WHETHER IN CONTRACT, STRICT LIABILITY, OR TORT (INCLUDING NEGLIGENCE OR OTHERWISE) ARISING IN ANY WAY OUT OF THE USE OF THIS SOFTWARE, EVEN IF ADVISED OF THE POSSIBILITY OF SUCH DAMAGE.

Barracuda Products may contain programs that are Copyright (c) 1998-2003 Carnegie Mellon University. All rights reserved. Redistribution and use in source and binary forms, with or without modification, are permitted provided that the following conditions are met: 1. Redistributions of source code must retain the above copyright notice, this list of conditions and the following disclaimer. 2. Redistributions in binary form must reproduce the above copyright notice, this list of conditions and the following disclaimer in the documentation and/or other materials provided with the distribution. The name "Carnegie Mellon University" must not be used to endorse or promote products derived from this software without prior written permission. For permission or any other legal details, please contact Office of Technology Transfer Carnegie Mellon University 5000 Forbes Avenue Pittsburgh, PA 15213-3890 (412) 268-4387, fax: (412) 268-7395 [tech-transfer@andrew.cmu.edu](mailto:tech-transfer@andrew.cmu.edu) .Redistributions of any form whatsoever must retain the following acknowledgment: "This product includes software developed by Computing Services at Carnegie Mellon University (<http://www.cmu.edu/computing/>)." CARNEGIE MELLON UNIVERSITY DISCLAIMS ALL WARRANTIES WITH REGARD TO THIS SOFTWARE, INCLUDING ALL IMPLIED WARRANTIES OF MERCHANTABILITY AND FITNESS, IN NO EVENT SHALL CARNEGIE MELLON UNIVERSITY BE LIABLE FOR ANY SPECIAL, INDIRECT OR CONSEQUENTIAL DAMAGES OR ANY DAMAGES WHATSOEVER RESULTING FROM LOSS OF USE, DATA OR PROFITS, WHETHER IN AN ACTION OF CONTRACT, NEGLIGENCE OR OTHER TORTIOUS ACTION, ARISING OUT OF OR IN CONNECTION WITH THE USE OR PERFORMANCE OF THIS SOFTWARE.

Barracuda products may include programs that are covered by the Apache License or other Open Source license agreements. The Apache license is re-printed below for you reference. These programs are copyrighted by their authors or other parties, and the authors and copyright holders disclaim any warranty for such programs. Other programs are copyright by Barracuda Networks.

Apache License  
Version 2.0, January 2004  
<http://www.apache.org/licenses/>

## TERMS AND CONDITIONS FOR USE, REPRODUCTION, AND DISTRIBUTION

### 1. Definitions.

"License" shall mean the terms and conditions for use, reproduction, and distribution as defined by Sections 1 through 9 of this document.

"Licensor" shall mean the copyright owner or entity authorized by the copyright owner that is granting the License.

"Legal Entity" shall mean the union of the acting entity and all other entities that control, are controlled by, or are under common control with that entity. For the purposes of this definition, "control" means (i) the power, direct or indirect, to cause the direction or management of such entity, whether by contract or otherwise, or (ii) ownership of fifty percent (50%) or more of the outstanding shares, or (iii) beneficial ownership of such entity.

"You" (or "Your") shall mean an individual or Legal Entity exercising permissions granted by this License.

"Source" form shall mean the preferred form for making modifications, including but not limited to software source code, documentation source, and configuration files.

"Object" form shall mean any form resulting from mechanical transformation or translation of a Source form, including but not limited to compiled object code, generated documentation, and conversions to other media types.

"Work" shall mean the work of authorship, whether in Source or Object form, made available under the License, as indicated by a copyright notice that is included in or attached to the work (an example is provided in the Appendix below).

"Derivative Works" shall mean any work, whether in Source or Object form, that is based on (or derived from) the Work and for which the editorial revisions, annotations, elaborations, or other modifications represent, as a whole, an original work of authorship. For the purposes of this License, Derivative Works shall not include works that remain separable from, or merely link (or bind by name) to the interfaces of, the Work and Derivative Works thereof.

"Contribution" shall mean any work of authorship, including the original version of the Work and any modifications or additions to that Work or Derivative Works thereof, that is intentionally submitted to Licensor for inclusion in the Work by the copyright owner or by an individual or Legal Entity authorized to submit on behalf of the copyright owner. For the purposes of this definition, "submitted" means any form of electronic, verbal, or written communication sent to the Licensor or its representatives, including but not limited to communication on electronic mailing lists, source code control systems, and issue tracking systems that are managed by, or on behalf of, the Licensor for the purpose of discussing and improving the Work, but excluding communication that is conspicuously marked or otherwise designated in writing by the copyright owner as "Not a Contribution."

"Contributor" shall mean Licensor and any individual or Legal Entity on behalf of whom a Contribution has been received by Licensor and subsequently incorporated within the Work.

2. Grant of Copyright License. Subject to the terms and conditions of this License, each Contributor hereby grants to You a perpetual, worldwide, non-exclusive, no-charge, royalty-free, irrevocable copyright license to reproduce, prepare Derivative Works of, publicly display, publicly perform, sublicense, and distribute the Work and such Derivative Works in Source or Object form.

3. Grant of Patent License. Subject to the terms and conditions of this License, each Contributor hereby grants to You a perpetual, worldwide, non-exclusive, no-charge, royalty-free, irrevocable (except as stated in this section) patent license to make, have made, use, offer to sell, sell, import, and otherwise transfer the Work, where such license applies only to those patent claims licensable by such Contributor that are necessarily infringed by their Contribution(s) alone or by combination of their Contribution(s) with the Work to which such Contribution(s) was submitted. If You institute patent litigation against any entity (including a cross-claim or counterclaim in a lawsuit) alleging that the Work or a Contribution incorporated within the Work constitutes direct or contributory patent infringement, then any patent licenses granted to You under this License for that Work shall terminate as of the date such litigation is filed.

4. Redistribution. You may reproduce and distribute copies of the Work or Derivative Works thereof in any medium, with or without modifications, and in Source or Object form, provided that You meet the following conditions:

(a) You must give any other recipients of the Work or Derivative Works a copy of this License; and

(b) You must cause any modified files to carry prominent notices stating that You changed the files; and

(c) You must retain, in the Source form of any Derivative Works that You distribute, all copyright, patent, trademark, and attribution notices from the Source form of the Work, excluding those notices that do not pertain to any part of the Derivative Works; and

(d) If the Work includes a "NOTICE" text file as part of its distribution, then any Derivative Works that You distribute must include a readable copy of the attribution notices contained within such NOTICE file, excluding those notices that do not pertain to any part of the Derivative Works, in at least one of the following places: within a NOTICE text file distributed as part of the Derivative Works; within the Source form or documentation, if provided along with the Derivative Works; or, within a display generated by the Derivative Works, if and wherever such third-party notices normally appear. The contents of the NOTICE file are for informational purposes only and do not modify the License.

You may add Your own attribution notices within Derivative Works that You distribute, alongside or as an addendum to the NOTICE text from the Work, provided that such additional attribution notices cannot be construed as modifying the License.

You may add Your own copyright statement to Your modifications and may provide additional or different license terms and conditions for use, reproduction, or distribution of Your modifications, or for any such Derivative Works as a whole, provided Your use, reproduction, and distribution of the Work otherwise complies with the conditions stated in this License.

5. Submission of Contributions. Unless You explicitly state otherwise, any Contribution intentionally submitted for inclusion in the Work by You to the Licensor shall be under the terms and conditions of this License, without any additional terms or conditions. Notwithstanding the above, nothing herein shall supersede or modify the terms of any separate license agreement you may have executed with Licensor regarding such Contributions.

6. Trademarks. This License does not grant permission to use the trade names, trademarks, service marks, or product names of the Licensor, except as required for reasonable and customary use in describing the origin of the Work and reproducing the content of the NOTICE file.

7. Disclaimer of Warranty. Unless required by applicable law or agreed to in writing, Licensor provides the Work (and each Contributor provides its Contributions) on an "AS IS" BASIS, WITHOUT WARRANTIES OR CONDITIONS OF ANY KIND, either express or implied, including, without



limitation, any warranties or conditions of TITLE, NON-INFRINGEMENT, MERCHANTABILITY, or FITNESS FOR A PARTICULAR PURPOSE. You are solely responsible for determining the appropriateness of using or redistributing the Work and assume any risks associated with Your exercise of permissions under this License.

8. Limitation of Liability. In no event and under no legal theory, whether in tort (including negligence), contract, or otherwise, unless required by applicable law (such as deliberate and grossly negligent acts) or agreed to in writing, shall any Contributor be liable to You for damages, including any direct, indirect, special, incidental, or consequential damages of any character arising as a result of this License or out of the use or inability to use the Work (including but not limited to damages for loss of goodwill, work stoppage, computer failure or malfunction, or any and all other commercial damages or losses), even if such Contributor has been advised of the possibility of such damages.

9. Accepting Warranty or Additional Liability. While redistributing the Work or Derivative Works thereof, You may choose to offer, and charge a fee for, acceptance of support, warranty, indemnity, or other liability obligations and/or rights consistent with this License. However, in accepting such obligations, You may act only on Your own behalf and on Your sole responsibility, not on behalf of any other Contributor, and only if You agree to indemnify, defend, and hold each Contributor harmless for any liability incurred by, or claims asserted against, such Contributor by reason of your accepting any such warranty or additional liability.

## END OF TERMS AND CONDITIONS

APPENDIX: How to apply the Apache License to your work.

To apply the Apache License to your work, attach the following boilerplate notice, with the fields enclosed by brackets "[]" replaced with your own identifying information. (Don't include the brackets!) The text should be enclosed in the appropriate comment syntax for the file format. We also recommend that a file or class name and description of purpose be included on the same "printed page" as the copyright notice for easier identification within third-party archives.

Copyright [yyyy] [name of copyright owner]

Licensed under the Apache License, Version 2.0 (the "License"); you may not use this file except in compliance with the License. You may obtain a copy of the License at

<http://www.apache.org/licenses/LICENSE-2.0>

Unless required by applicable law or agreed to in writing, software distributed under the License is distributed on an "AS IS" BASIS, WITHOUT WARRANTIES OR CONDITIONS OF ANY KIND, either express or implied. See the License for the specific language governing permissions and limitations under the License.

### Source Code Availability

Per the GPL and other "open source" license agreements the complete machine readable source code for programs covered by the GPL or other "open source" license agreements is available from Barracuda Networks at no charge. If you would like a copy of the source code or the changes to a particular program we will gladly provide them, on a CD, for a fee of \$100.00. This fee is to pay for the time for a Barracuda Networks engineer to assemble the changes and source code, create the media, package the media, and mail the media. Please send a check payable in USA funds and include the program name. We mail the packaged source code for any program covered under the GPL or other "open source" license.